

ANYLOAD®

808 Series
Industrial LED
Remote Display



CE

TECHNICAL MANUAL

V20-07

TABLE of CONTENTS:

1.	INTRODUCTION	2
1.1	Main Features.....	2
1.2	Technical Specifications	3
2.	INSTALLATION	4
2.1	Safety Precautions.....	4
2.2	Main Enclosure	5
2.3	Opening Enclosure	8
2.4	Wall Mounting.....	9
2.5	Pole Mounting	9
2.6	Wireless Installation	10
3.	WIRING.....	11
3.1	Controller Board Terminals	11
3.2	Electrical Power Wiring.....	12
3.3	Serial Communication Wiring.....	13
3.4	Multiple Display Wiring.....	14
3.5	Switch and Relay Wiring	15
4.	CONFIGURATION	16
4.1	Function Setup Menu	16
4.2	Operating Modes.....	16
4.3	Membrane Keypad	17
4.4	F1 Display Setting.....	19
4.5	F2 Utility Setting	20
4.6	F3 Protocol Setting.....	21
4.7	F4 Communication Setting	22
4.8	F5 Auxiliary Setting	23
5.	UTILITIES	24
5.1	Multiple Display	24
5.2	Traffic Light.....	25
6.	TROUBLESHOOTING.....	27
6.1	Controller Board	27
6.2	Error Codes	28
6.3	Display Messages.....	28
6.4	Push Buttons.....	28
6.5	Diagnostic Lights.....	29
6.6	Advance Diagnostic.....	29
6.7	Protocol Example.....	30
6.8	Multiple Display	30
6.9	Applications	32

I. ABOUT THIS MANUAL

Thank you for choosing Anyload 808A/B/CH industrial remote display. This 808A/B/CH technical manual provides installation, setup, operation, and configuration information for the 808A/B/CH industrial remote display. This manual is intended to be used by trained service technicians and installers. It is recommended to go through the manual in details before installing, operating or configuring the instrument. For further information please contact Anyload Weigh & Measure Inc. authorized dealer.

II. DISCLAIMER



Information in this Technical Manual is subject to change without notice due to correction or enhancement. The information described in this manual is the property of Anyload Weigh & Measure Inc. All other brand or product names within this publication are trademarks or registered trademarks of their respective companies. All information contained within this publication is, to the best of our knowledge, complete and accurate at the time of publication.

ANYLOAD® Is a registered trademark of Anyload Weigh & Measure Inc. Copyright © 2019 Anyload Weigh & Measure Inc. All rights reserved.

III. SAFETY

Standard safety practices are required before conducting any installation, maintenance, or procedure on device. It is recommended to read and understand the instructions and warnings in this manual before performing any procedure on device. Failure to follow the instructions and warnings could result in injury or death.

Definition of the safety symbols is described in table below.

Symbol	Description
	WARNING! Indicates a potentially hazardous situation which may result in serious injury or death Indicates a potentially dangerous procedure which may cause injury or death
	CAUTION! Indicates a potentially wrong procedure which may result in damage to device Indicates a potentially wrong procedure which may result in loss of warranty
	NOTICE! Indicates a procedure which may need more instructions Indicates a procedure which has more information available

1. INTRODUCTION

1.1 MAIN FEATURES

- Designed and developed by Anyload Weigh & Measure Inc. in Canada.
- Six digits LED industrial remote display, with option of RED/GREEN.
- High intensity, wide viewing angle, double row discrete LEDs.
- Standard seven segments with capability to display alphanumerical characters.
- Automatic learn mode to set communication baud rates.
- Automatic learn mode to detect incoming strings format.
- Ambient light sensor for day and night brightness control.
- Adjustable brightness settings for day and night.
- Software configuration for custom string formats.
- Menu driven setup function using a membrane keypad.
- Switch inputs and a relay output module to control traffic light.
- Customized software utility programs for truck axle weighing and summation.
- Customized addressable configuration to daisy chain multiple remote displays.
- Up to two decimal places with choice of dot or comma.
- Reverse digits mode for visibility in mirrors.
- Standard wall mount and pole mount kits.
- Standard sun visor and rain shade.
- Indication of GROSS (GR) and NET (NT) status by annunciators.
- Indication of KG (kg) and LB (lb), or T (t) units by annunciators.
- Independent ESD protected RS232, RS422/RS485 and 20mA serial communications.
- Echo out port for RS-232 and RS-422/RS-485 serial communications.
- Metal enclosure with hinged front cover for easy service.
- Weather proof mild steel powder coated enclosure.
- Internal folding electronic plate for easy wiring.
- Semitransparent grey front safety glass.
- UL approved encapsulated multi sense voltage power supply.
- Breather ventilation to avoid condensation inside enclosure.

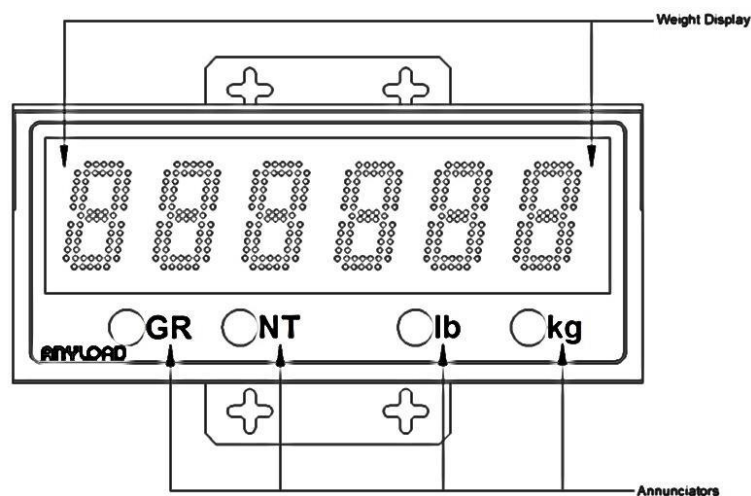

1.2 TECHNICAL SPECIFICATIONS

Item	Specification	Description
1	Display Digits	5" (125mm) height, 6 digits, 7 segments for 808AH and 808BH 6" (150mm) height RED / GREEN balls for 808BH 2 1/2" (60mm) height , 6 digits, 7 segments for 808CH
2	Digit Segments	1500mcd high intensity brightness, 120° viewing angle, discrete red CREE® LED
3	Micro Controller	50MHZ ARM Cortex M® processor
4	Status Indication	4 annunciators for GR, NT, kg, lb, or t / 2 extra for 808CH
5	Decimal Point	2 decimal point places with choice of dot or coma
6	Membrane Keypad	4 keys domed membrane keypad
7	Brightness Control	550nm ambient light sensor to adjust brightness in day and night
8	Communication Ports	3 independent serial ports for RS232, RS422/RS485, and 20mA current loop
9	Communication Baud	Auto learn 300,600,1200,2400,4800,9600,19200,38400,57600 baud rate
10	String Protocol	Auto learn to detect string protocol and parse incoming string
11	Echo Port	2 independent serial ports for RS232 and RS422/RS485
12	Printer Port	1 independent transmit port for none legal for trade printing applications
13	Digital Output	1 form C relay output rated at 2A / 60VDC
14	Digital inputs	2 independent dry contact switch inputs
15	Main Enclosure	Mild steel powder coated NEMA 4 / IP65 weather proof suitable for outdoor applications
16	Power Supply	Input: 100-240VAC, 1.2A, 50/60Hz / output: 12VDC, 5.0A, 60W encapsulated
17	Power Consumption	120VAC @ 0.5A / 12VDC @ 2.5A (60W AC / 30W DC) typical 808AH 120VAC @ 0.7A / 12VDC @ 3.5A (80W AC / 40W DC) typical 808BH 120VAC @ 0.3A / 12VDC @ 1.5A (30W AC / 20W DC) typical 808CH
18	Operating Temperature	-40°F to 120°F (-40°C to 50°C)
19	Operating Humidity	20%RH to 90%RH
20	Enclosure Ventilation	GORE® breather vent to avoid condensation
21	Physical Dimensions	22.8" W X 9.8" H X 5.9" D (579mm X 250mm X 149mm) 808AH 32.5" W X 9.8" H X 5.9" D (825mm X 250mm X 149mm) 808BH 11.7" W X 7.5" H X 2.7" D (296mm X 191mm X 67mm) 808CH
22	Total Weight	7.5 kg (17 lb) main unit and 1.5 kg (3 lb) mounting kits, approximately 808AH 12.5 kg (23 lb) main unit and 1.5 kg (3 lb) mounting kits, approximately 808BH 6.5 kg (12 lb) main unit, approximately 808CH
23	Industry Approvals	UL / cUL approved class II power supply, CB CE, CE Marked



2. INSTALLATION

2.1 SAFETY PRECAUTIONS

Please practice safety before conducting any installation, maintenance, or procedure on device.

- ✓ The 808A/B/CH remote displays are pre-wired AC devices with multi sense voltage.
- ✓ It is necessary to practice safety checks before any installation or maintenance.
- ✓ Do not operate this device unless all instructions in this manual have been read.
- ✓ All installation and maintenance shall be conducted by trained service technicians.
- ✓ Avoid any alteration or changes to the device other than factory provided options.
- ✓ Disconnect power source before any installation or maintenance.
- ✓ Make sure proper grounding is provided at the site.
- ✓ Make sure device is properly grounded if custom wiring is provided.
- ✓ Make sure site structure can bear weight of the remote display.
- ✓ Make sure enough clearance is available around the device for accessibility.
- ✓ Make sure all warning signs are visible and not damaged or altered.
- ✓ Follow warning and caution notes in this manual.



Symbol	Description
	WARNING! Make sure the power source is disconnected before any installation Make sure the site has proper grounding
	CAUTION! Any unauthorized change or alteration in default wiring may void warranty Any installation and wiring must be handled by authorized personnel
	NOTICE! Refer to the local electrical code for the wiring color codes Refer to the installation section for instructions to how to access to the wiring terminals

2.2 MAIN ENCLOSURE

The main enclosures of the 808A/B/CH are hinged design metal enclosure protected by two toggle latches on the sides for easy service. The enclosure is a weather proof mild steel powder coated with both standard pole mount and wall mount brackets included in the package. All internal parts are installed on a folding metal plate mounted inside of the enclosure.

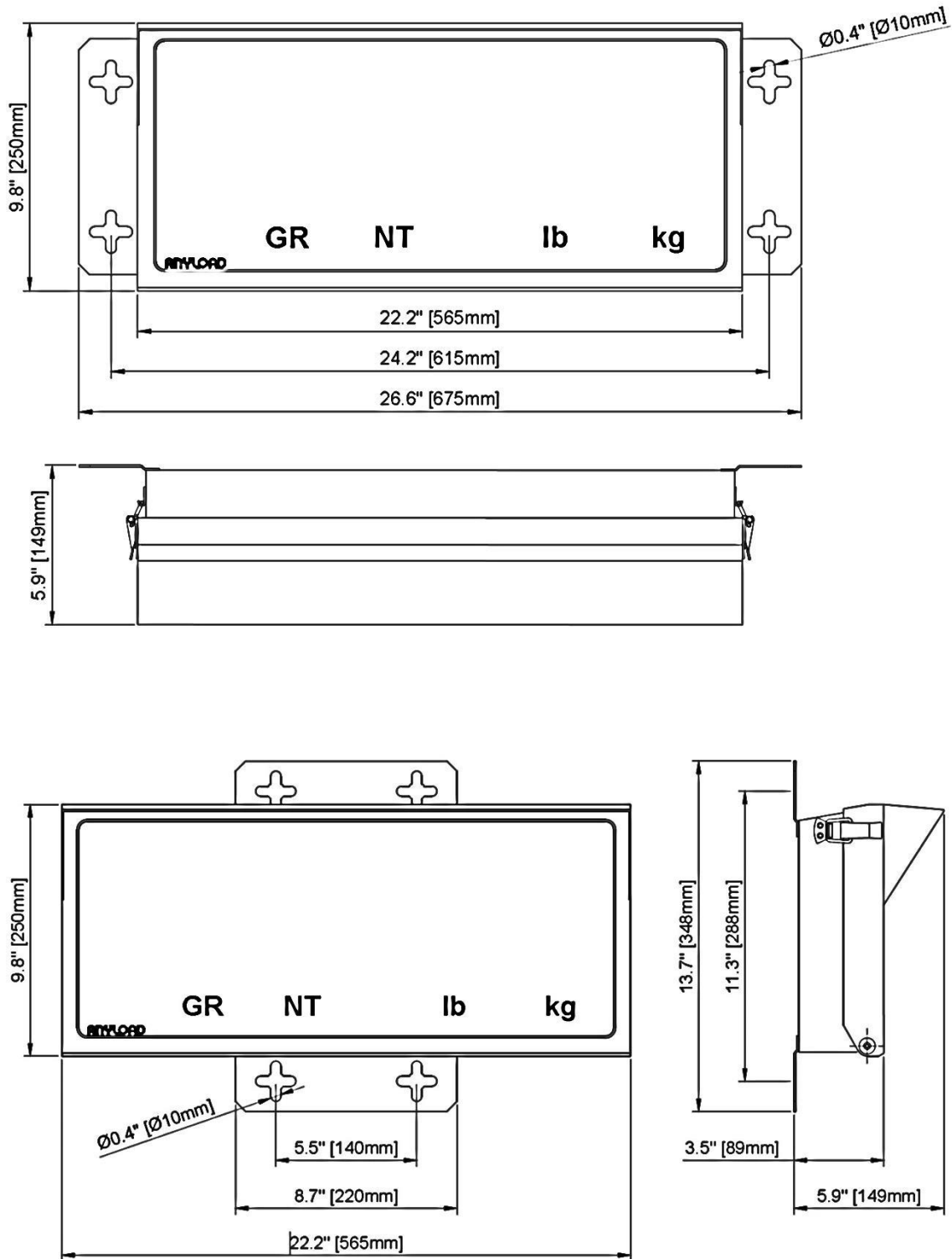

- THE 808BH WITH BUILT IN TRAFFIC LIGHT MODEL

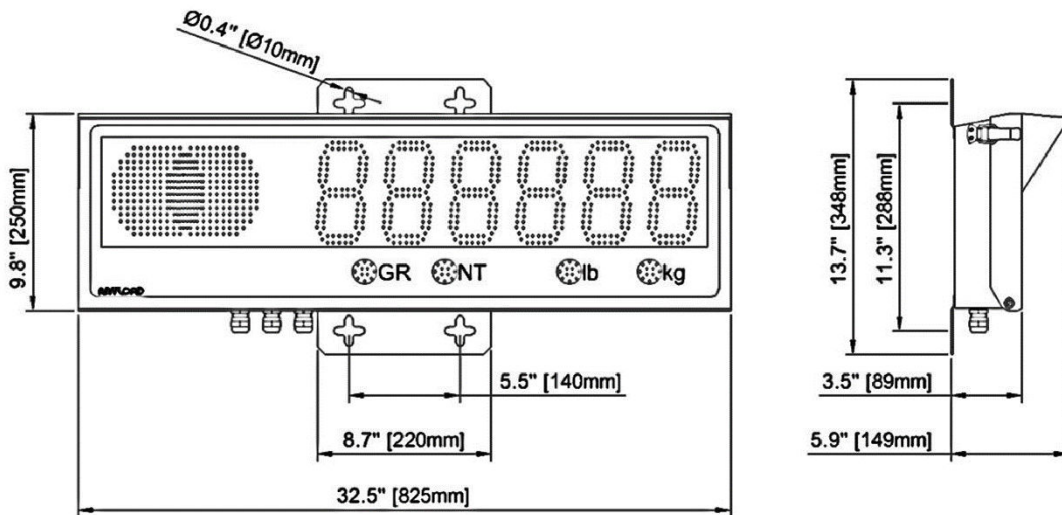
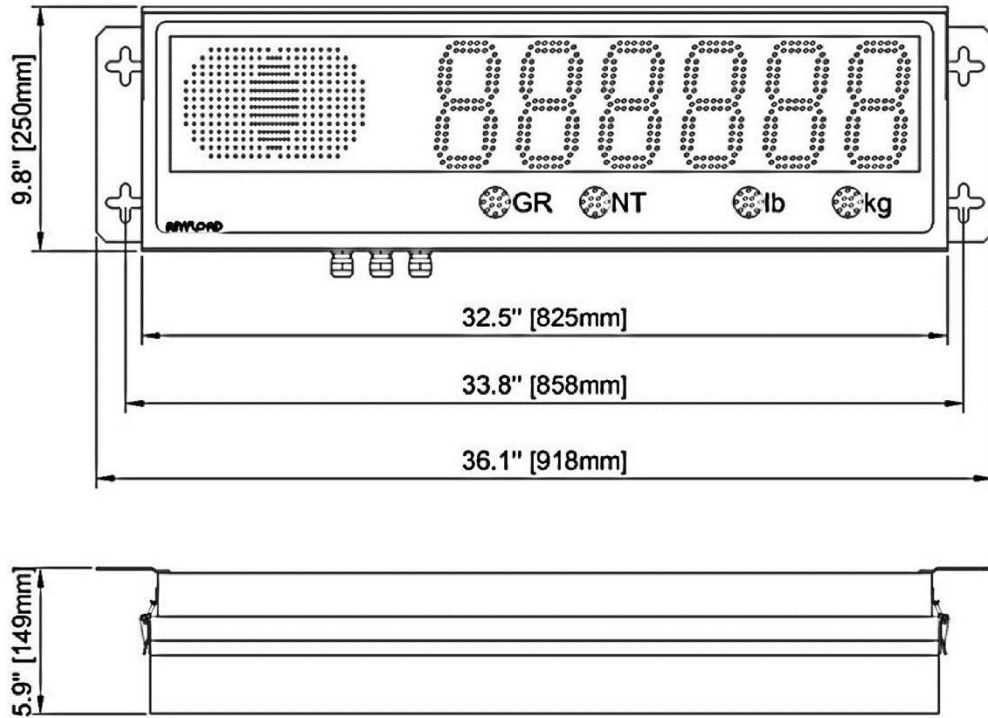

- THE 808CH COMPACT MODEL

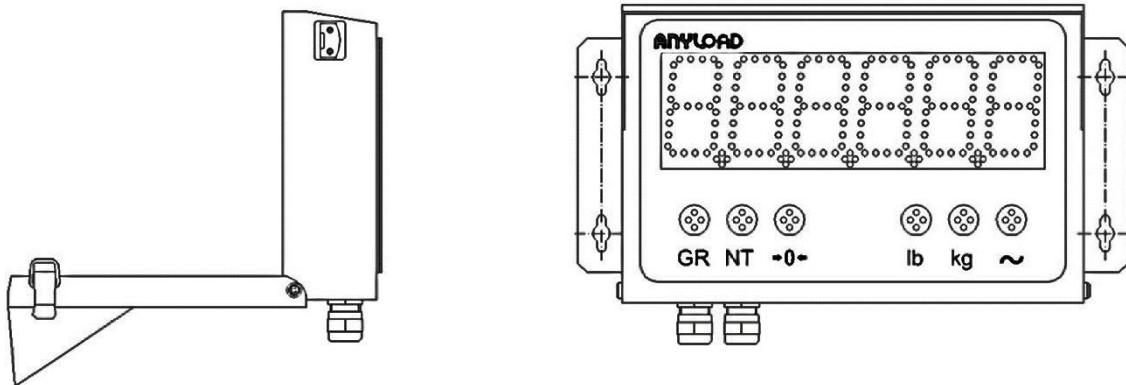
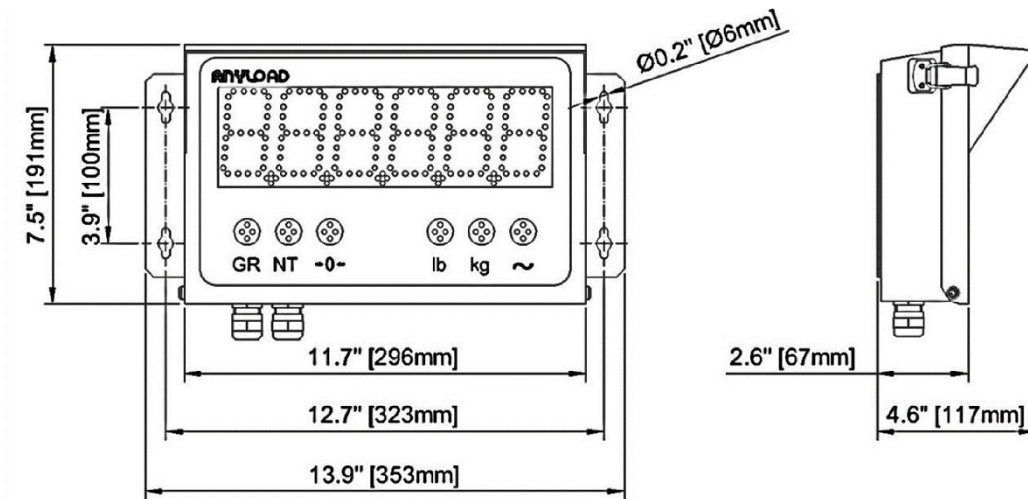

2.3 OPENING ENCLOSURE

To open the cover, unlatch the two toggle latches on both sides of the enclosure and flip down the hinged front cover. To access the electronic components, loosen two retention screws on each side of the electronic plate of the 808AH remote display.

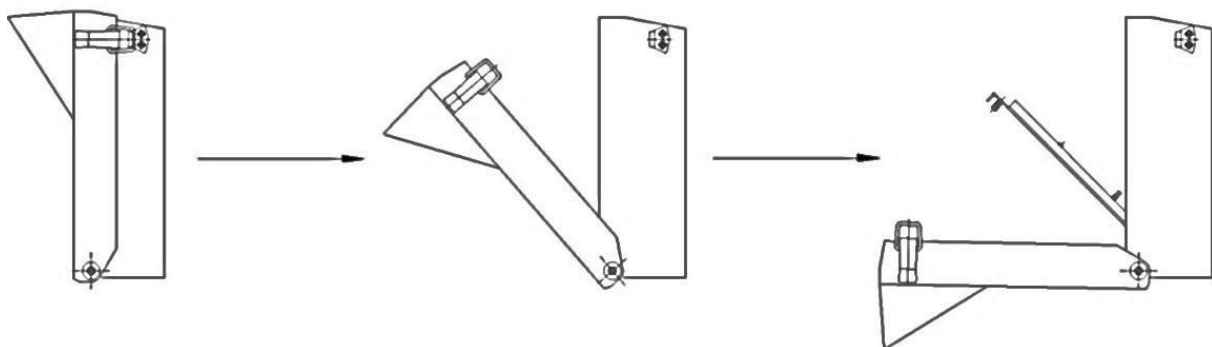
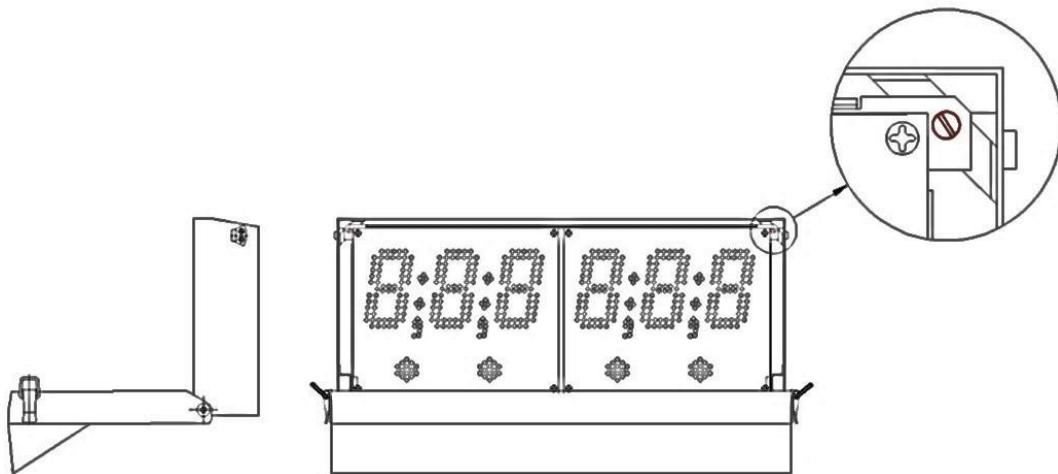
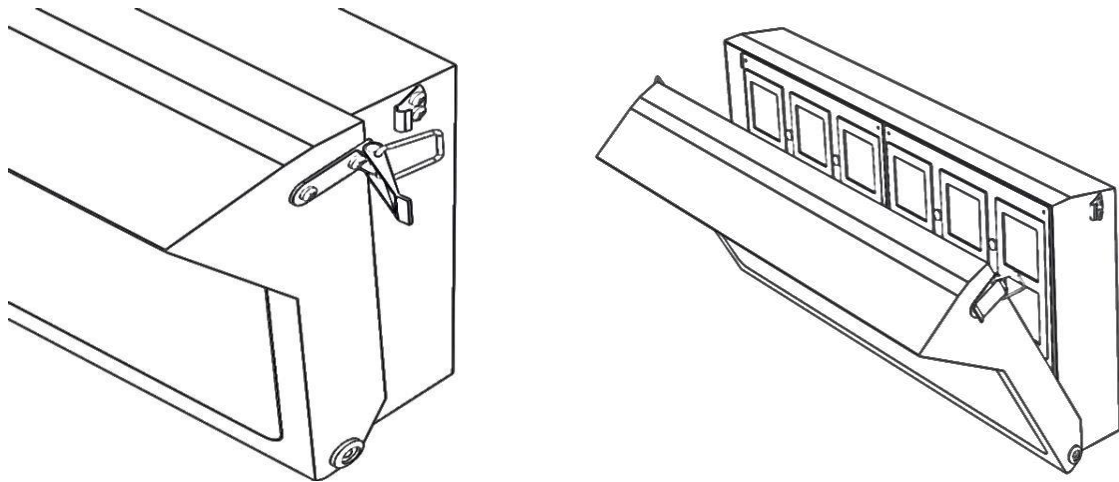

2.4 WALL MOUNTING

The 808A/B/CH remote displays may be mounted on walls with standard ear mount pieces provided in the package. The ear mount pieces can be attached to the main enclosure by six philips type screws.

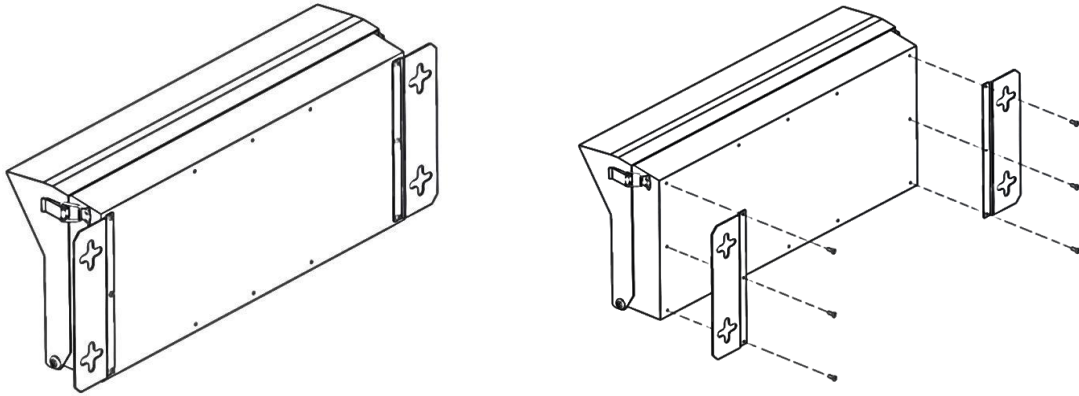

2.5 POLE MOUNTING

The 808A/BH remote displays may be mounted on the poles by standard pole mount kit provided in the package. The pole mount kit includes two ear mount pieces connected to the main enclosure by six Philips screws, and a pole mount. Have the pole mount fixed on the pole first, then install the enclosure with the ear mount pieces attached on it.

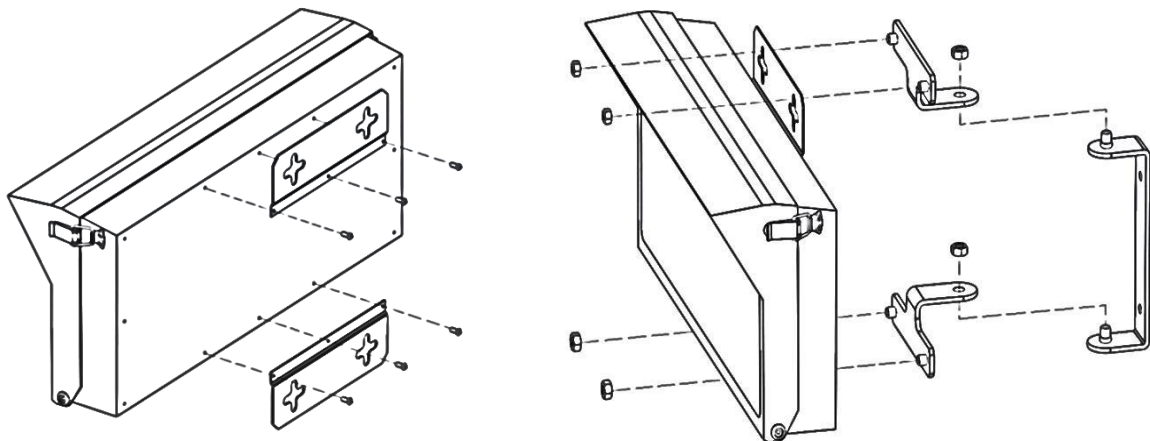

2.6 WIRELESS INSTALLATION

The hardware configuration of the 808AH/BH/CH large display to a wireless display is explained below. The wireless conversion kit consists of:

- Wireless module
- Antenna
- Antenna cable



- *ASSEMBLY INSTRUCTIONS:*

Install the wireless module in the correct orientation on the main board. Make sure the pins are aligned properly. Mount the other end of the antenna cable on the large display enclosure.



Install the antenna outside the unit at the bottom.



Symbol	Description
	<p>NOTICE! The Wireless kit is an electronic sensitive device The wireless kit must be installed, and handled with care to avoid any ESD damage Make sure the power source is disconnected before any installation</p>

3. WIRING

3.1 CONTROLLER BOARD TERMINALS

All communication signals, switch inputs, and outputs can be terminated to the controller board via accessible screw terminals. These terminals are designed to accept serial data communication signals, dry contact switch inputs, and a relay output.

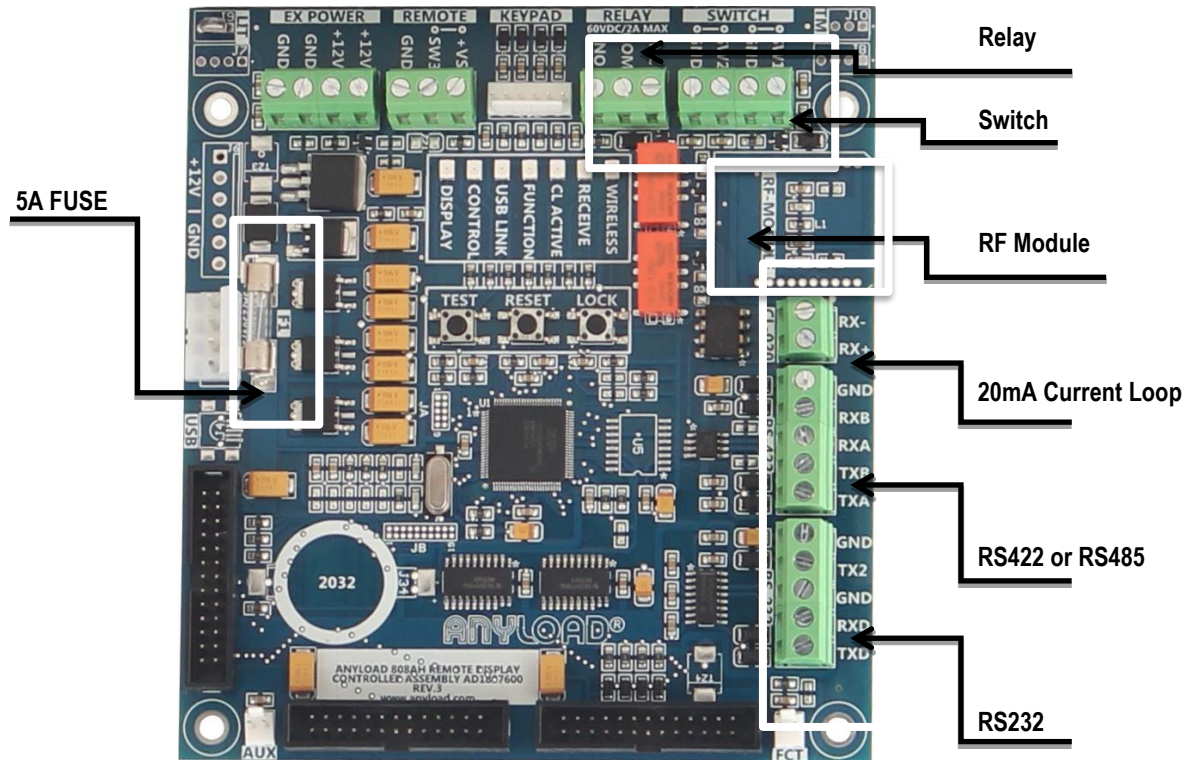

Item	Protocol	Distance
1	RS-232	50 feet (15 m)
2	RS-422/RS-485	1000 feet (300 m)
3	20mA	500 feet (150 m)

Symbol	Description
	<p>NOTICE!</p> <p>Availability of the options is subject to confirmation by manufacturer and may vary by firmware version Refer to the configuration section for instructions on how to configure the functions of remote display Refer to the installation section for instructions on how to access the wiring terminals</p>



3.2 ELECTRICAL POWER WIRING

The 808A/B/CH remote displays are pre-wired AC devices with regional power cable cord installed via strain reliefs. The proper grounding is provided as default. The standard 808A/B/CH remote displays do not have any ON / OFF power switch. Therefore, before any installations, make sure all power sources are disconnected.

It is required to use a ground fault circuit interrupter to supply AC lines to the device at the site to avoid any risk or hazard. For the applications requiring custom wiring, all safety precautions and proper grounding must be considered. This table is based on color codes commonly used in North America. For other regions, the local codes must be obtained and observed.

Power Cord		Power Supply	
Wire	Color	Color	Wire
Neutral	White	Blue	N
Live	Black	Brown	L
	Green	-	

Item	AC Power Supply	Description
1	Input	AC 100-240V~ 1.2A 50-60HZ for AH and BH (AC 100-240V~ 1.1A 50-60HZ for CH)
2	Output	DC 12V 5A 60W for AH and BH models (DC 12V 3A 35W for CH models)
3	Enclosure	Encapsulated IP67
4	Protection	Short circuit, Over load, Over voltage
5	Approval	Class II UL / cUL approved, with CB CE

Symbol	Description
	<p>WARNING!</p> <p>Make sure the power source is disconnected before any installation Make sure the site has proper grounding</p>
	<p>CAUTION!</p> <p>Any unauthorized change or alteration in default wiring may void warranty Any installation and wiring must be handled by authorized personnel</p>
	<p>NOTICE!</p> <p>Refer to the local electrical code for the wiring color codes Refer to the installation section for instructions to how to access to the wiring terminals</p>

3.3 SERIAL COMMUNICATION WIRING

The 808A/B/CH remote displays provide industry standard serial communication ports with installation via screw terminals. The ports are automatically detected and adjusted upon start up. There are three communication ports available as RS-232, RS-422, RS-485, and 20mA current loop in both active and passive mode. The serial communication wires coming from indicator shall be entered to the unit via bottom strain reliefs and be terminated to the proper terminals.

Communication	Indicator	808AH	Description
Protocol	RS-232	RS-232	Function
RS-232 Communication RS-232 Printer Port	-	GND	Signal Ground
	-	TX2	Printer Port Transmit Data
	GND	GND	Signal Ground
	TX	RXD	Transmit to Receive Data
	-	TXD	Transmit Data

Communication	Indicator	808AH	Description
Protocol	RS-485	RS-422	Function
RS-422 Communication RS-485 Communication	GND	GND	Signal Ground
	TXB	RXB	Negative Transmit to Negative Receive Data
	TXA	RXA	Positive Transmit to Positive Receive Data
	-	TXB	Negative Transmit Data
	-	TXA	Positive Transmit Data

Communication	Indicator	808AH	Description
Protocol	20mA	CL-020	Function
20mA Current Loop Passive or Active	TX-	RX-	Negative Transmit to Negative Receive Data
	TX+	RX+	Positive Transmit to Positive Receive Data

Symbol	Description
	<p>NOTICE!</p> <p>Availability of the printer port is subject to confirmation by manufacturer and may vary by firmware version Refer to the F4 section for instructions on how to configure communication ports of remote display Refer to the F4 section for instructions on how to configure passive or active mode of 20mA port Refer to the installation section for instructions on how to access the wiring terminals</p>

3.4 MULTIPLE DISPLAY WIRING

Depending on the application and distances, one of the following methods can be used for multiple remote displays in a multi-drop mode. Up to ten 808A/B/CH remote displays can be wired in multi scale mode. Echo out ports functionality is disabled as default and can be activated in setup menu. The table below shows the wiring and configuration of fours remote displays.

808AH Multi Display	Indicator	808AH #1	808AH #2	808AH #3	808AH #4
Protocol	RS-232	RS-232/RS485	RS-485	RS-485	RS-485
RS-232 TO RS-422 / RS-485	TXD	RXD	-	-	-
	RXD	-	-	-	-
	-	TXA	RXA	RXA	RXA
	-	TXB	RXB	RXB	RXB
	GND	GND	GND	GND	GND

808AH Multi Display	Indicator	808AH #1	808AH #2	808AH #3	808AH #4
Protocol	RS-485	RS-485	RS-485	RS-485	RS-485
RS-422 / RS-485 TO RS-422 / RS-485	TXA	RXA	RXA	RXA	RXA
	TXB	RXB	RXB	RXB	RXB
	GND	GND	GND	GND	GND

808AH Multi Display	Indicator	808AH #1	808AH #2	808AH #3	808AH #4
Protocol	RS-232	RS-232	RS-232	RS-232	RS-232
RS-232 TO RS-232	TXD	RXD	-	-	-
	-	TXD	RXD	-	-
	-	-	TXD	RXD	-
	-	-	-	TXD	RXD
	GND	GND	GND	GND	GND

Symbol	Description
	<p>NOTICE!</p> <p>Availability of the utility programs are subject to confirmation by manufacturer and may vary by firmware Refer to the F2 section for instructions on how to configure multiple remote displays Refer to the F4 section for instructions on how to configure echo out ports Refer to the installation section for instructions on how to access the wiring terminals</p>



3.5 SWITCH AND RELAY WIRING

The input switches SW1 and SW2 can be used to control the output relay and also to control the display to show prompt messages as set. The input switches are designed to accept both momentary and toggle switches. The switches only accept dry contact as input configuration.

Terminal	Pin	Label	Function
SWITCH	1	SW1	Dry Contact Switch, Active Low Short to GND
	2	GND	Signal Ground
	3	SW2	Dry Contact Switch, Active Low Short to GND
	4	GND	Signal Ground

Switch 2	Switch 1	Relay	Description
---	Open (H)	NC	GREEN External Traffic Light
---	---	COM	Common for External Voltage
---	Closed (GND)	NO	RED External Traffic Light

Switch 2	Switch 1	Display	Description
Open (H)	Open (H)	None	No Message On Display
Open (H)	Closed (GND)	Message 1	Message 1 Display is Activated by SW1
Closed (GND)	Open (H)	Message 2	Message 2 Display is Activated by SW2
Closed (GND)	Closed (GND)	None	No Message on Display

Symbol	Description
	WARNING! The switches only accept dry contact as inputs The relay contact is limited to 2A/60VDC Make sure the site has proper grounding
	CAUTION! The switches only accept dry contact as inputs Any unauthorized change or alteration in default wiring may void warranty Any installation and wiring must be handled by authorized personnel
	NOTICE! The switch and relay functions are disabled as default Refer to the configuration section for instructions to how to configure inputs and outputs Refer to the installation section for instructions to how to access to the wiring terminals

4. CONFIGURATION

4.1 FUNCTION SETUP MENU

The function setup menu is consisted of different function blocks used to set different configuration values of 808A/B/CH remote displays. There are five function blocks currently available for configuration showed in the table below.

Block	Menu	Description
	DISPLAY	Functions Related to Digits Display
	UTILITIES	Functions Related to Utilities and Special Programs
	FORMAT	Functions Related to String Formats and Protocols
	SERIAL	Functions Related to Data Communications and Serial Ports
	AUXILIARY	Functions Related to Switch Inputs and Relay Outputs
	-	N/A
	-	N/A
	-	N/A
	DIAGNOSTIC	Advance Diagnostics

4.2 OPERATING MODES

Mode	Description
AUTOMATIC	Attempts to learn communication speed (baud) and parse string format (protocol) at start up. It is set as default and active only at start up. Once it is successful, it can be switched to other modes. Onboard FUNCTION LED will blink fast at four times a second.
PRESET	Sets the functions based on its internal directory of known communication rates and string formats. It is useful if auto learn mode has been successful. Then it can be activated to avoid unnecessary delay and changes startup. Onboard FUNCTION LED will blink normal once a second.
MANUAL	Sets the functions based on its manually set values stored in its memory. It is useful if auto learn mode has not been successful or display is not aligned correctly. Then it can be used to set communication rate and string format manually. Onboard FUNCTION LED will blink slowly once every two seconds.

4.3 MEMBRANE KEYPAD

The setup menu is used to configure main operating functions of the 808A/B/CH remote display. A four keys membrane keypad, located at bottom of the enclosure, is used to enter into, exit from, and navigate through setup menu functions.

To enter into setup menu, press and hold ◀ & ▶ keys together for two seconds. To exit from setup menu, use the same keys combination. To navigate through menus, press short or hold ◀ or ▶ keys. To enter into or exit from a sub menu press ○ key. To change a sub menu value, press ◀ or ▶ keys. To exit from setup, without saving, press and hold TEST button.

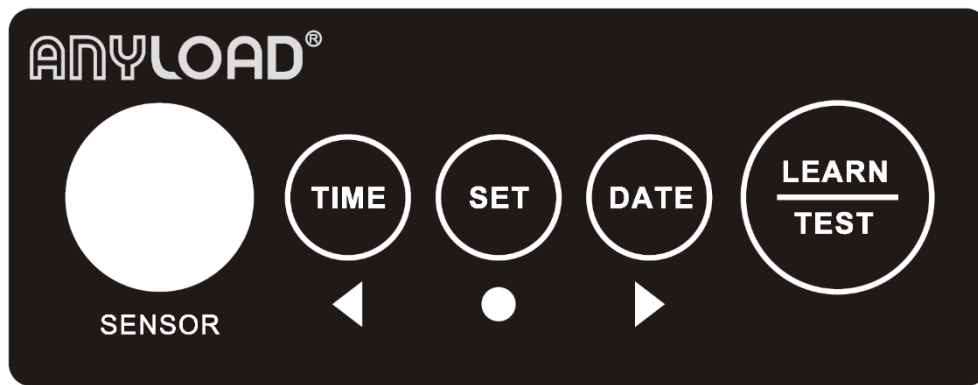

Keypad	Key	Function	Description
		Short press: LEARN Long press: TEST	LEARN: Attempts to learn communication baud and format of an incoming data. TEST: Advance testing and adjusting the display.
		Short press: FX.X - 0.1 Long press: FX.X - 1.0	LEFT : Short Press: Decrements subsection categories, FX.X. Long Press: Decrements section categories, FX.
		Short press: SET Long press: ABORT	SET: Short Press: Entering into section categories FX.X. Short Press: Accepting the value of a subsections FX.X. Long Press: Returning to section categories FX.
		Short press: FX.X + 0.1 Long press: FX.X + 1.0	RIGHT : Short Press: Increments subsection categories, FX.X. Long Press: Increments section categories, FX.

- *ENTERING INTO SETUP MENU*

Press and hold ◀ & ▶ keys together simultaneously for two seconds to enter setup menu, the SETUP message will appear. Then first function block F1.0 will be displayed.

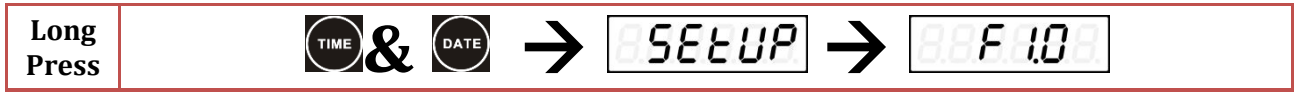

- *NAVIGATING THROUGH MENU*

To navigate through the menu, press ◀ or ▶ keys. A short press will cause FX.X to increase or decrease by 0.1 (move within the submenu) and a long press will increase or decrease by 1 (exit the submenu and go to the root menu).

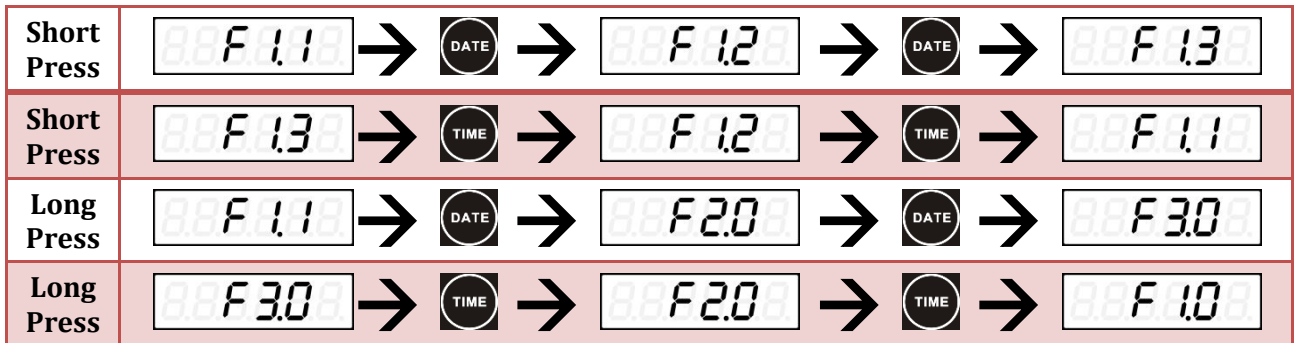

- *EDITING SUBMENU VALUES*

Press ○ key to enter the shown submenu and the current setting of that submenu will be displayed. Press ◀ or ▶ keys to change the value of the submenu as required.

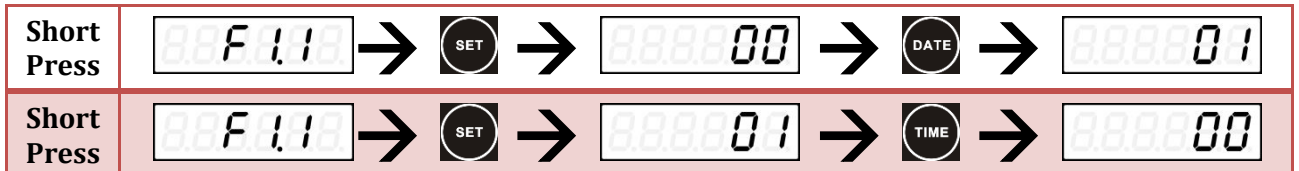

- *SETTING SUBMENU VALUE*

Press ○ key to accept the selected value and return to the submenu. A FX.X message showing corresponding function block will be displayed.



- *EXITING FROM SETUP MENU*

Press and hold ◀ & ▶ keys together simultaneously to save and exit the setup menu. A SAVED message will be displayed and then it will reset. To exit without saving, press and hold TEST button.



4.4 F1 DISPLAY SETTING

Function	Value	Setting	Description
F1.0 Factory Reset	0 1	Abort Factory	If set 1, remote display will reset its functions to default factory settings.
F1.1 Setup Lockout	0 1	Allowed Prevented	If set 1, any changes to settings is prevented. This is useful to disable setup menu to avoid unwanted changes.
F1.2 Energy Saving	0 1 2 3	Disabled Level 1 Level 2 Level 3	Manages energy saving by adjusting the brightness. If set 0, energy saving is disabled. If set 1, display reduces brightness if no activity on display for 15 min. If set 2,3, display reduces brightness if scale weight at 0 for 15 min.
F1.3 Day / Night Brightness Control	0 1	Disabled Enabled	If set 0, brightness level is always set to day time level. If set 1, light sensor is active and monitors day and night.
F1.4 Day Time Brightness Setting	100 80 50 20	100 % 80 % 50 % 20 %	Sets day time brightness level. Brightness level is shown in percentage. Daytime is monitored by onboard light sensor.
F1.5 Night Time Brightness Setting	100 80 50 20	100 % 80 % 50 % 20 %	Sets night time brightness level. Brightness level is shown in percentage. Nighttime is monitored by onboard light sensor.
F1.6 Startup Test	0 1	Disabled Enabled	Runs display test at startup as default.
F1.7 Blank On Motion	0 1	Disabled Enabled	If set 1, blanks display on motion condition.
F1.8 Mirror Display	0 1 2	Disabled Enabled Toggle	Used to reverse display to be visible in truck mirrors. If set 1, it shows display in reverse. If set 2, it toggles display in every 3 seconds. If set 0, the function is disabled.
F1.9 Filter Display	0.25 0.50 0.75 1.00	0.25 sec 0.5 sec 0.75 sec 1 sec	Sets display update refresh time in seconds. It can be used based on sensitivity of the indicator. It can be used combined with blank on motion function.

4.5 F2 UTILITY SETTING

Function	Value	Setting	Description
F2.0 Utility Programs	0 1 2 3 4 5	0 1 2 3 4 5	Utility programs used for custom applications. Special programs used for multi display applications. The programs availability may vary based on the firmware. Refer to Section 5
F2.1 Multiple Remote Address	0 1 2 3 4 5 6 7 8 9	ld 0 ld 1 ld 2 ld 3 ld 4 ld 5 ld 6 ld 7 ld 8 ld 9	It is used in multiple display applications. Each remote display has an address in multi display applications. Address 0 is considered broadcasting data to all displays. Availability of this function is based on firmware release. Refer to Section 5
F2.2 Data Timeout Default	10 20 30 40 50 60	10 sec 20 sec 30 sec 40 sec 50 sec 60 sec	It sets display timeout in seconds if communication is lost. It is used for regular programs as default unless mentioned otherwise. The display shows dashes or blank if received data is timed out.
F2.3 Data Timeout Custom	0.00 0.25 0.50 1.00 1.50	0 min 0.25 min 0.5 min 1 min 1.5 min	It sets display timeout in minutes if communication is lost. It is used for special programs and message modes. If set 0, the display holds last showing. If none 0, the display shows dashes or blank if is timed out.
F2.4 Data Timeout Message	0.00 0.25 0.50 1.00 1.50	0 min 0.25 min 0.5 min 1 min 1.5 min	It sets display timeout in minutes if communication is lost. It is used for special programs and message modes. If set to 0.00, the display holds the last showing, otherwise, the display shows dashes or blank if it is timed out.
F2.5 Data Lost	0 1	Dash Blank	If communication is lost, display shows dashes or simply goes blank.
F2.6 Suppressing Zero	0 1	Auto Suppress	It suppresses leading zeros in strings containing leading zeros.
F2.7 Leading Zero	0 1 2	Auto 00 000	Adds two or three leading zeros in legal for trade applications.
F2.8 Decimal Character	0 1	Dot Comma	Decimal points can be displayed as dot or comma.
2.9 Over Range	000000 to 999999	000000 to 999999	The weight range can set a display maximum value. The display will show OVER if weight is out of the set range. Use short and long press keys to change value and digit respectively. If set to 000000, the Over Range function is off.



4.6 F3 PROTOCOL SETTING

Function	Value	Setting	Description
F3.0 Operating Modes	0 1 2	Auto Preset Manual	Auto mode attempts to learn communication protocols at startup. Preset mode uses its internal saved table to set best format. Manual mode scans regularly to find best format.
F3.1 String Length	1-50	1-50	It determines total length of an incoming string.
F3.2 Weight Position	1-50	1-50	It determines start position of weight in a string.
F3.3 Weight Length	3-50	3-50	It determines number of weight numerical characters in a string.
F3.4 End Character Main	01 02 03 04 10 13	SOH STX ETX EOT LF CR	It sets end character of regular strings unless is mentioned otherwise. Default is <CR>.
F3.5 End Character Special	01 02 03 04 10 13	SOH STX ETX EOT LF CR	It sets end character in special programs. It used for special utility programs available in utility setting. Default is <CR>.
F3.6 Decimal Point	Auto 0.0 0.00 none	Auto 0.0 0.00 None	If set to Auto, it detects decimal point from the incoming string as default. If set to 0.0, it shows one decimal place. If set to 0.00, it shows two decimal places. If set to None, the decimal point is OFF.
F3.7 Status Annunciators	Auto Gr NT none	Auto GR NT None	If set to Auto, it detects status from an incoming string as default. If set to GR, it locked to show gross weight. If set to NT, it locked to show net weight. If set to None, both Status Annunciators will be OFF.
F3.8 Units Annunciators	Auto Lb kg none	Auto lb kg None	If set to Auto, it detects unit from an incoming string as default. If set to lb, It locked to LB to show pounds. If set to kg, It locked to KG to show kilogram. If set to None, both Status Annunciators will be OFF.
F3.9 Over Load	Auto OU CC EE none	Auto O C E	It determines over / under load conditions. It searches O in string. It searches C in string. It searches E in string. If set None, over cap is off.

4.7 F4 COMMUNICATION SETTING

Function	Value	Setting	Description
F4.0 Communication Mode	<input type="checkbox"/> <i>Auto</i> <input type="checkbox"/> <i>BAud</i>	Auto Manual	If set to Auto, It will learn the communication baud rate at startup. If set to Manual, it uses its previously saved value to be the communication baud rate.
F4.1 Communication Port	<input type="checkbox"/> <i>RS-232</i> <input type="checkbox"/> <i>RS-422</i> <input type="checkbox"/> <i>CL-020</i> <input type="checkbox"/> <i>RF-900</i>	RS232 RS422/485 20mA Loop RF Wireless	It shows currently used communication port for serial communication. It is set to RS232 as default. Wireless option is not available with this version.
F4.2 Serial Communication Baud Rate	300 600 1200 2400 4800 9600 19200 32800 57600	300 600 1200 2400 4800 9600 19200 32800 57600	It sets and shows current communication baud rate. If F4.0 set to Auto, it shows current baud rate detected. If F4.0 set to Manual, it shows current baud rate setting.
F4.3 Parity	0 1 2	8 bits 7 bits even 7 bits odd	8 bits data no parity as default. 7 bits data even parity. 7 bits data odd parity.
F4.4 Echo Out Communication Port	<input type="checkbox"/> <i>none</i> <input type="checkbox"/> <i>RS-232</i> <input type="checkbox"/> <i>RS-422</i> <input type="checkbox"/> <i>both</i>	Disabled RS232 RS422 Both	It sets which COM port used to echo out data for multiple displays. It is used in multi display applications. It is disabled as default.
F4.5 Current Loop Active Mode	<input type="checkbox"/> <i>PAS Iu</i> <input type="checkbox"/> <i>ACT Iu</i>	Passive Active	It sets 20mA current loop mode to passive or active mode. Set to passive mode if the indicator supplies current as default. Set to active mode if the indicator is in passive mode. To use this function refer to indicator user manual for proper setting.

4.8 F5 AUXILIARY SETTING

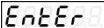
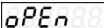
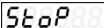
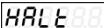
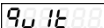
Function	Value	Setting	Description
F5.0 Switch Function	0 1 2	Disabled Momentary Latch	If set to Disable, both SW1 and SW2 are disabled as default. If set to Momentary, both SW1 and SW2 are active as push buttons. If set to Latch, both SW1 and SW2 are active in latched mode. Refer to Section 5.
F5.1 Relay Function	0 1	Disabled Enabled	If set to 1, relay function is active. It operates based on SW1 current state. It is disabled as default. Refer to wiring chapter and relay section of this technical manual.
F5.2 Traffic Light Function	0 1 2 3 4 5 6 7 8 9	Disabled 1 2 3 4 5 6 7 8 9	Disable as default controlled by software. Refer to Section 5.
F5.3 Switch 1 Message	0 1 2 3 4	Disabled    	It shows predefined messages on display if SW1 is not disabled. Refer to the wiring chapter and switch section of the manual. Default messages are as follows: CLOSED DRIVE START ENTER
F5.4 Switch 2 Message	0 1 2 3 4	Disabled    	It shows predefined messages on display if SW2 is not disabled. Refer to the wiring chapter and switch section of the manual. Default messages are as follows: OPEN STOP HALT QUIT

5. UTILITIES



5.1 MULTIPLE DISPLAY

Depending on the application up to ten 808A/B/CH remote displays can be configured in multi display mode. The echo out ports functionality is disabled as default and can be activated in setup menu. The table below shows the configuration and setup of remote displays in multi display mode.

Function	Value	Setting	Description
F2.0 Utility Programs	6	6	Utility programs used for custom applications. The program 6 sets remote display for multiple display mode and command control
F2.1 Multiple Remote Address	0 1 2 3 4 5 6 7 8 9	ld 0 ld 1 ld 2 ld 3 ld 4 ld 5 ld 6 ld 7 ld 8 ld 9	It is used in multiple display applications. Each remote display has an address in multi display applications. Address 0 is considered broadcasting data to all displays.

To set an address to send data to the desired remoter display, send the string as follows:
1 <CR>, it sets the address to 1.

To send data to a remote display with desired address, send the data followed by <CR>.
#1 <CR> 10000KN <CR>, It displays 10000 KG NET on display 1.
#2 <CR> @ HELLO <CR>, It displays "HELLO" on display 2.

Symbol	Description
	WARNING! For wiring instructions of multiple refer to section 3 Wiring For wiring instructions of SW1 and SW2 refer to section 3 Wiring
	CAUTION! Any unauthorized change or alteration in default wiring may void warranty Any installation and wiring must be handled by authorized personnel
	NOTICE! Refer to the configuration for instructions to how to configure utility programs Refer to the configuration for instructions to how to configure echo out ports

5.2 TRAFFIC LIGHT

The RED /GREEN built in lights in 808BH models can be controlled in different methods. It can be controlled by on board switches, installed programs, or command by indicators.

The RED / GREEN lights can be controlled via SW1 and SW2 as follows:

Function	Value	Setting	Control by SW1 and SW2
F5.0 Switch Function	0	Disabled	If set to Disable, both SW1 and SW2 are disabled as default. If set to Momentary, both SW1 and SW2 are active as push buttons.
	1	Momentary	
F5.2 Traffic Light Function	0	Disabled	RED / GREEN controlled by software
	1	GREEN / RED	RED / GREEN controlled by SW1
	2	GREEN / RED	RED / GREEN controlled by SW1 and SW2
	3	BLINKING G/R	RED / GREEN controlled by SW1 in blinking mode
	4	N/A	N/A
	5	N/A	N/A
	6	GREEN	GREEN is locked
	7	RED	RED is locked
	8	N/A	N/A
9	OFF	RED / GREEN is OFF	

The RED / GREEN lights can be controlled by several installed programs as follows:

Function	Value	Setting	Control by Installed Programs
F2.0 Utility Programs	0	0	Normal
	1	1	GREEN at zero / RED at none zero
	2	2	RED on motion / GREEN on stable
F5.0 Switch Function	0	Disabled	If set to 0, both SW1 and SW2 are disabled as default. The RED / GREEN is controlled by software
F5.2 Traffic Light Function	1	GREEN / RED	RED / GREEN Solid

The RED / GREEN lights can be controlled by serial ASCII commands sent by indicators as follows:

Function	Value	Setting	Controlled by Commands
F2.0 Utility Programs	3	3	Include commands in the string: For RED use "&", and for GREEN use "*". Example: 10000LBGR* <CR> will display 10000 lb and GREEN
	6	6	Send commands to control RED / GREEN
F5.0 Switch Function	0	Disabled	If set to Disable, both SW1 and SW2 are disabled as default.
F5.2 Traffic Light Function	1	GREEN / RED	RED / GREEN.

When the utility program is set to 6, the remote display is set to multiple display mode accepting serial ASCII commands. The commands to set RED / GREEN are as follows:

To send command to remote display @ is used as command header followed by a command.

An example is as follows:

@ & <CR > will set traffic light RED.

ASCII	Command	Function
&	RED	Set traffic light to RED
*	GREEN	Set traffic light to GREEN
%	OFF	Turn traffic light OFF
\$	BLINKING R	Set traffic light in blinking RED
^	BLINKING G	Set traffic light in blinking GREEN
(FLASHING ON	Flashes weight display every seconds
)	FLASHING OFF	Undo flashing display to solid weight

6. TROUBLESHOOTING

The 808A/B/CH remote displays have comprehensive tools for troubleshooting, including diagnostic lights, onboard push buttons, error codes, message codes, and advance diagnostics inside setup menu. In cases where the display is not detected, shifted, or displaced, diagnostic tools can be used to identify the problems.



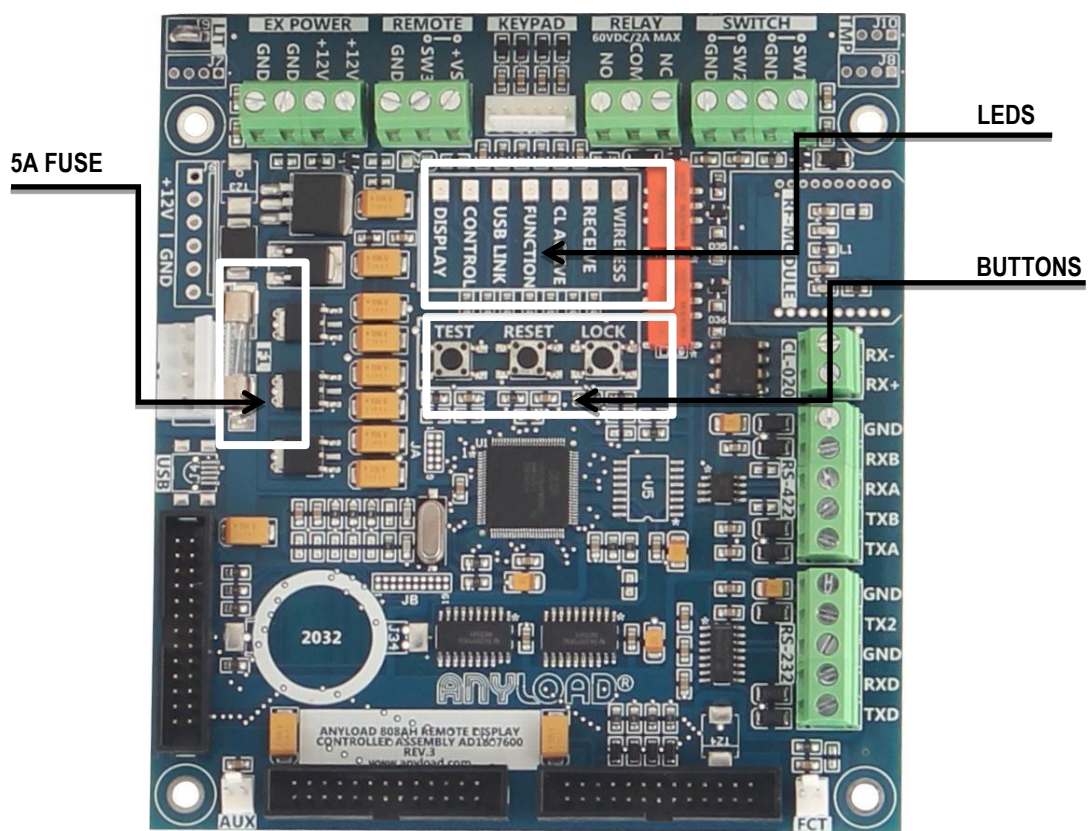

A glass type fuse is located on board to protect digit boards. It is installed on a socket and is replaceable. The fuse is rated at 5A/250V and is slow blow.

6.1 CONTROLLER BOARD



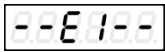
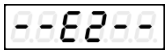

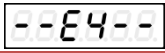

Symbol	Description
	<p>NOTICE!</p> <p>Fuse is rated at 5A/250V slow blow glass type Refer to the troubleshooting diagnostic lights and push buttons section for more information Refer to the configuration section for more information on advance diagnostic</p>

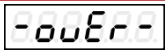

6.2 ERROR CODES

Error	Description	Action
	Communication baud rate failure	Check wirings for proper connection
	Incoming string protocol failure	Check Indicator to be in continuous mode
	Wireless communication failure	Check installed RF module
	Factory setting failure	Perform factory reset
	Memory checksum failure	Perform factory reset
	Data communication failure	Check communication setting, wiring and indicator

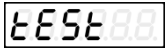





6.3 DISPLAY MESSAGES

Message	Description	Reason
	Shows dashes or blanks display	Data communication failure
	OCAP for over capacity on scale	Set by indicator by sending a special character
	OVER for out of range weight setting	Set by remote display in setup menu
	LEARN for auto learn baud and protocol	Auto learn mode to detect baud rate and protocol
	SAVED for saving setup information	Setup data stored in flash memory
	TEST for running a display test	Display tests segments and brightness

6.4 PUSH BUTTONS

Button	Description	Function
<p>TEST</p> 	<p>TEST</p> <p>Tests brightness levels</p> <p>Tests display segments</p> <p>Tests annunciators</p>	<p>Performs a full display test</p>
<p>RESET</p> 	<p>RESET</p> <p>Runs a cycle test</p> <p>Loads startup values</p> <p>Shows version number</p>	<p>Performs a hardware reset</p>
<p>LOCK</p> 	<p>LOCK</p> <p>Loads protocol and baud from stored values</p> <p>Avoids unnecessary delays at start up</p> <p>Locks if learn is successful at start up</p>	<p>Locks to latest successful configuration</p>

6.5 DIAGNOSTIC LIGHTS

LED	Normal	Failure
DISPLAY 	If ON, 12V display voltage is present. If OFF, 12V display voltage has failed.	If OFF check the power supply If OFF check the fuse on board
CONTROL 	If ON, 3V control voltage is present. If OFF, 3V control voltage has failed.	If OFF check the power supply
USBLINK 	USB connection.	For service and manufacturer use only
FUNCTION 	Rapid blinking four times a second (1/4sec). Normal blinking once a second (1 sec). Slow blinking once every two seconds (2 sec).	Rapid: Automatic mode Normal: Preset mode Slow: Manual mode
CLACTIVE 	If ON, 20mA loop is in active mode. If OFF, 20mA loop is in passive mode.	Passive mode is used for the indicators supplying current Active mode is used for the indicators set in passive mode
RECEIVE 	If flashing, data is being received into the buffer. If OFF, communication has failed.	If OFF check wiring and indicator Check indicator to be set in continuous mode
WIRELESS 	If ON, wireless option is working properly. It is OFF if no RF module installed.	Not available with this version

6.6 ADVANCE DIAGNOSTIC

Function	Value	Setting	Description
F9.0 Character	XXXXXX	None	Character counter Shows number of ASCII characters received in buffer
F9.1 Numeric	XXXXXX	None	Numeric counter Shows number of ASCII numeric received in buffer
F9.2 String	XXXXXX	None	String counter Shows number of complete strings received in buffer
F9.3 Checksum	XXXXXX	None	Data checksum Shows memory checksum check failure
F9.4 Signal	XX	None	RF signal strength Shows wireless signal strength if it is installed
F9.5 Sensor	XXXX	None	Light sensor indicates day light if greater than 600 Shows light sensor value a number between 0 to 1400
F9.6 Version	XX-XX	None	Displays software version
F9.7 Model	XX-XX	None	Displays model number
F9.8 Protocol	XX	None	Reserved
F9.9 Reset	0 1	Abort Initialize	Alternative setup reset Resets all setup values to default, except string settings

6.7 PROTOCOL EXAMPLE

The standard string format to be received by 808A/B/CH includes start of the text character, weight numeric values, unit character, status character, and end of the text character. An example of string protocol for single remote display application connected to an indicator is illustrated below.

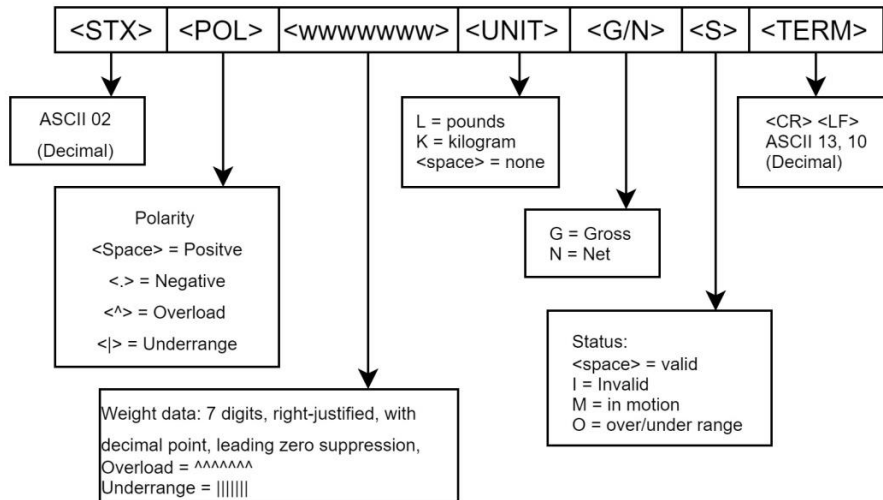

6.8 MULTIPLE DISPLAY

The 808AH remote display can be configured in a multiple display installations. Every remote display has a unique address to receive the string, and to display the weight data. This is useful in axle weighing programs, totalizing indicators, and multi scale programmable indicators. An example of string protocol for multiple remote display application including address identifier is illustrated below.

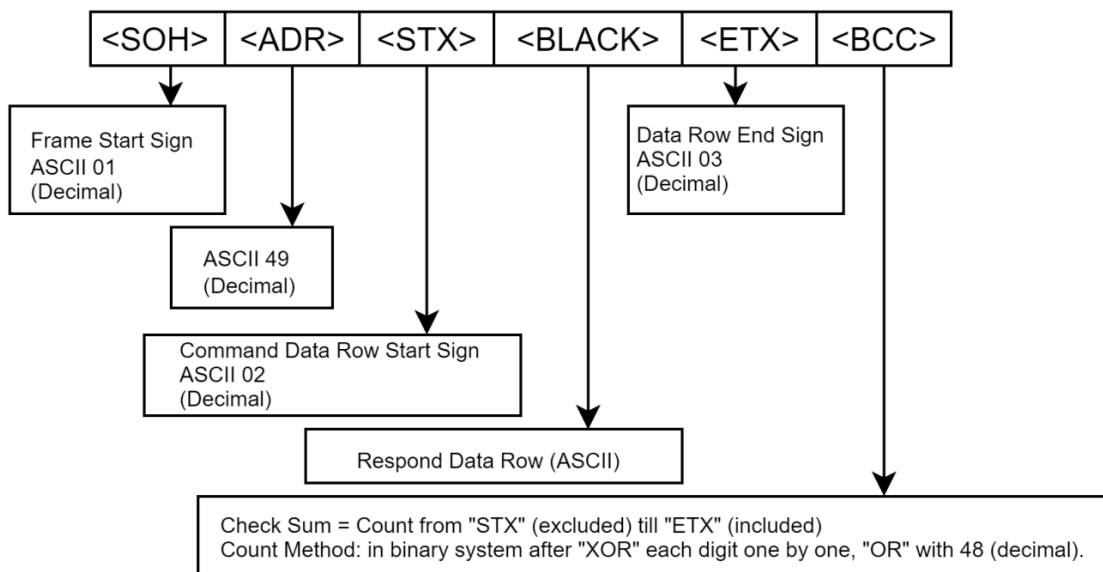

There are two main headers used in multi display mode as follows:

ASCII	Command	Function
#	ADDRESS Header	This command is to set address followed by <CR>
@	MESSAGE Header	This command is to display a message followed by <CR>

To send the weight, command, or a message to display, the address must be set accordingly.

To set an address to send data to the desired remoter display, send the string as follows:

1 <CR>, it sets the address to 1.

2 <CR>, it sets the address to 2.

To send data to a remote display with desired address, send the data followed by <CR>.

#1 <CR> 10000KN <CR>, It displays 10000 KG NET on display 1.

#2 <CR> @ HELLO <CR>, It displays "HELLO" on display 2.

To send data to multiple remote display alternatily, they can be sent in one single string as follows:

#1 10000KG #2 20000KG #3 30000KG #4 40000KG <CR>.

This commands display 10000kg on display 1, 20000kg on display 2, 30000kg on display 3, and 40000kg on display 4.

To send a message to multiple remote displays @ header is used as follows:

#1 <CR>, it sets the address to 1.

@ HELLO<CR>, display HELLO on display 1.

#2 <CR>, it sets the address to 2.

@ STOP<CR>, display STOP on display 2.

#3 <CR>, it sets the address to 3.

@ DRIVE<CR>, display DRIVE on display 3.

#4 <CR>, it sets the address to 4.

@ ENTER<CR>, display ENTER on display 4

@ (<CR>, display flashing ENTER on display 4

@) <CR>, ENTER on display 4

6.9 APPLICATIONS

The following illustrations will show how the WL900 wireless transmitter can be used in conjunction with the indicators, external switches, and large displays.



Please Contact Our Authorized Dealer for Technical Assistance:

North America Toll Free: 1-855-ANYLOAD (269-5623)
Email: info@anyload.com
Web: www.anyload.com

Content is subject to change without notice.

ANYLOAD®

Anyload is an ISO 90001 Certified Company.
© 2024 Anyload Weigh & Measure Inc. All Rights Reserved.

PN-240502

V20-07